



Bench-top Extrusion and Spheronization equipment
for the development of pellets from extrudate of variable density

- ✓ Maximise the chances of your R&D success
- ✓ Enhance your teaching efficiency
- ✓ Reduce operational expenses



Reduce bench-space requirement
Improve development speed by reducing the time needed for your trials
Investigate more parameters, more options with *Variable Density Extrusion*^(TM)
Save money in materials, equipment and by increased efficiency

GRANULATOR - EXTRUDER - SPHERONIZER

ALL-IN-ONE on the bench-top



Spheronizer

Extruder

Mixer / Granulator

DESCRIPTION

The Caleva Multi Lab (CML) incorporates:-

- ✓ A high shear mixer/granulator,
- ✓ An extruder
- ✓ A spheronizer

Within an "all-in-one" compact and robust bench top unit.

An extraordinary piece of equipment offering:-

- ✓ A demonstrated ability to reduce trial time by about 50%.
- ✓ Extrusion at different densities
- ✓ Reduced requirement of bench-top space

- ✓ The smallest possible batch sizes (10 to 100 grams - product dependant) saving on product usage and cost whilst remaining fully scalable.
- ✓ A range of extruder screws and dies with different properties to be appropriate for the widest range of products and your objectives.

The time saving ability of the CML together with the wide range of options and possibilities offers the R&D team the best chance of success in their development program and the highest level of teaching efficiency in university environments.

THE REMARKABLE CALEVA MULTI LAB PROVIDES AS STANDARD...

- A small base unit with a footprint just slightly larger than a sheet of A3 paper
- A mixer/high shear granulator for small batches designed to be multi-functional
- Two extrusion dies (one standard and one high density) for the extruder
- A 3 x 3 mm spheronizer plate with speed up to 4600 rpm
- All required plugs and leads, safety interlocks and safety covers
- Two different extrusion screws for use with different materials
- An automatic timer

Other options are available - see the following pages ...

Variable Density Extrusion^(TM)

Modify your extrudate density, hardness, friability and porosity at a trial level. Scalable to a larger bench-top extruder (for clinical, or other, larger trials) and a twin screw extruder (for production). Extrudate diameters from 0.5 mm to 3.0 mm on a range of dies offering “low pressure” to “high pressure” extrusion.

The unique CML offers, **as standard**, the possibility of variable density extrusion. As more investigation parameters are offered there is more chance of success with your formulation development.

The data shown opposite demonstrates that similar formulations can respond differently to extrusion at different densities.

Different extrusion density can potentially change the properties of a formulation increasing the chances of development success. The CML will enable research scientists to be 100% sure that all available alternatives have been fully investigated.

If your initial trials with variable density extrusion show promising results you have the option to obtain additional dies from Caleva that provide a higher or lower density output.



Extrudate density gain comparing standard to high density die

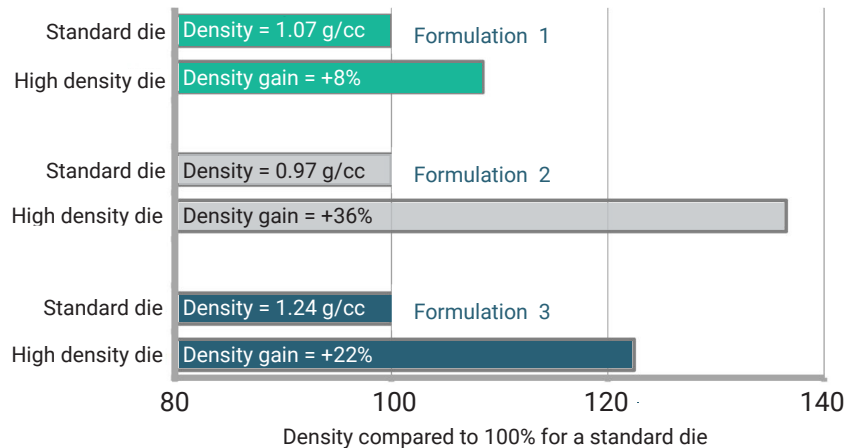

Dust generation comparing standard to high density die

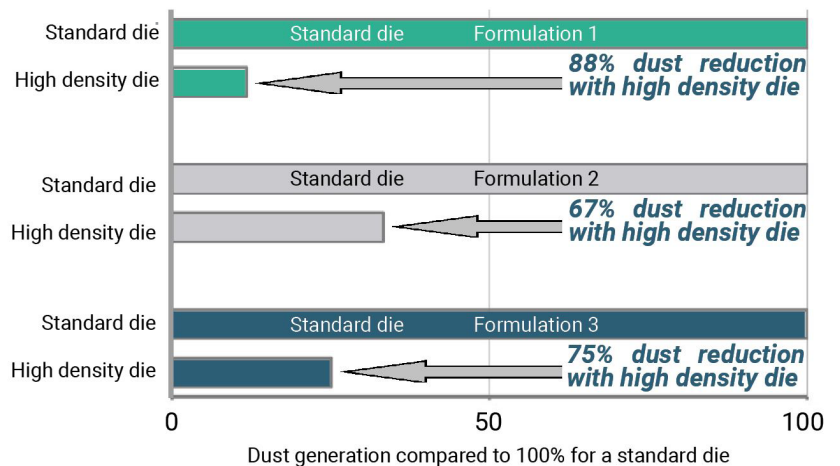

Porosity reduction comparing standard to high density die

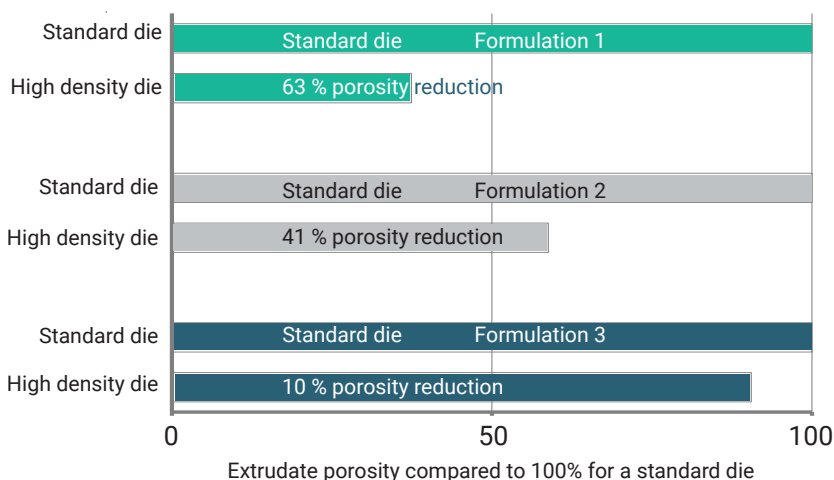

When you are developing pellets or making extrudate do you know what could happen if you modify the density of your extrudate ?

Possible options are:

- modify extrudate hardness and strength?
- modify the porosity of your extrudate?
- modify your product dissolution profiles?
- make your output more uniform?
- increase drug loading in a single dose unit?
- look at the effect on product cohesion and the effect on physical stability?
- look at the effect on chemical stability?

Optimize the extrusion density for your formulation and objectives
Increase the chances of your development success



PRODUCT INFORMATION

EXTRUSION OF “REAL-WORLD” FORMULATIONS WITH DIFFERENT CHARACTERISTICS

High Density die



Standard Die



Screw type A



Screw type B



Enhance the chances of your development success

- ✔ Change the density of your extrudate.
- ✔ Use the optimum screw design for your formulation.

Caleva offers a range of extruder dies to facilitate “**variable density extrusion**”. The CML comes with **one standard and one high density die** to get you started.

The standard CML unit is supplied with **extruder screws of two different design**. You can expand your range of “extrudable formulations”. Working with a wider range of options can **increase your chances of development success**.

REDUCE THE TIME REQUIRED TO COMPLETE YOUR TRIALS

Trials have **consistently demonstrated** that iterations can be completed in **less than half the time** required for other standard bench-top systems.

See our web site for **further details** and trial results.

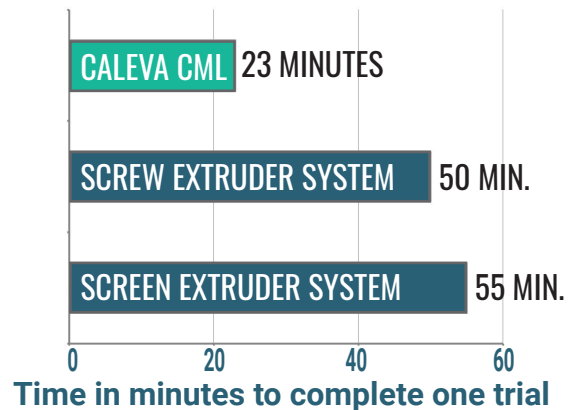

MULTI-FUNCTIONAL MIXER AND GRANULATOR

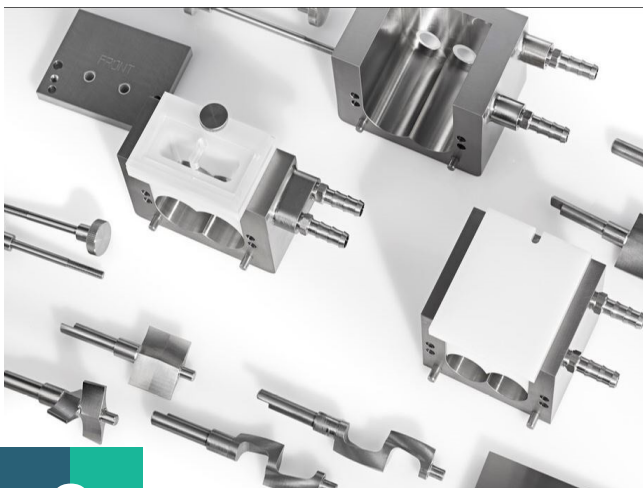

Useful for small batches of **creams, powders, pastes, gels, and powder/liquid combinations** in a wide range of proportions.

Bowls with or without **water jackets, bowls of different sizes**.

High viscosity bowl and blade sets.

Automatic timer offering **consistent results**, through consistent operating parameters.

The Mixer granulator is available as **a single separate unit**.

PRODUCT INFORMATION

SPECIALIST DIE AND BOWL / BLADE SETS FOR CATALYST AND CHEMICAL INDUSTRIES

Quad-lobe and tri-lobe dies in a range of sizes and density configurations that will allow you to **increase the surface area to volume ratio** of your extrudate.

Bowl and blades sets designed for use with **higher viscosity materials** are available.

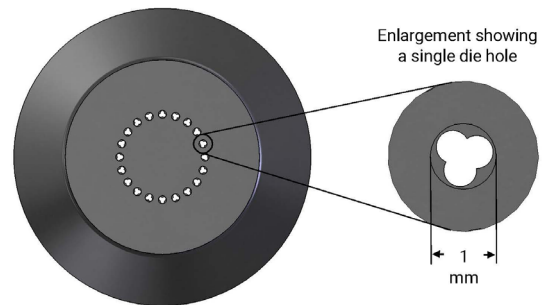

Tri-lobe die ("clover leaf") for the CML.
Other designs are possible. Ask us for details.

SPHERONIZER SUITABLE FOR A RANGE OF BATCH SIZES



Spheronizer **designed for batch sizes from the granulator and extruder** with the process visible to the operator.

Operator set automatic timer to achieve **repeatable spheronization**

Scalability and spheronization. The range of Caleva spheronizers is scalable throughout the range to 150 kg per hour production rates.

Variable Density Extrusion (TM) AND SCALABILITY

The Caleva Multi Lab is designed for **10-100 g samples**.

When scale up is required:-

- ✓ Caleva Variable Density Extruder (VDE) available **for batches from 0.25 to 5 kg.**
- ✓ Caleva Twin Screw Extruder (VD-TSE) can offer an **output of up to 150 kg per hour.**

Variable density dies are available throughout the range of Caleva screw type extruders.



VDE



VD-TSE

TECHNICAL SPECIFICATIONS



Caleva CML base unit with several granulator options

Variable Density Extrusion™

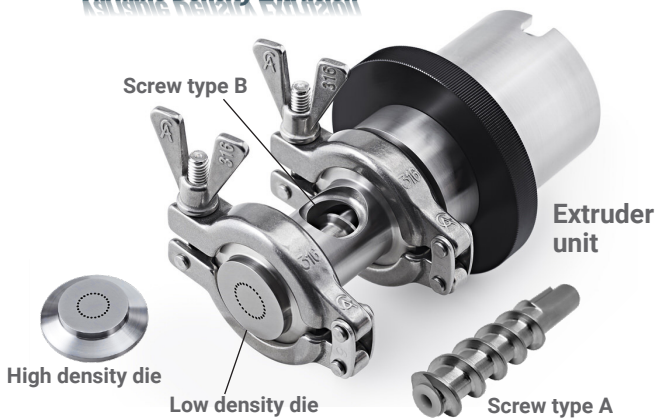

The units

Base unit

- Mixer/Granulator system
- Variable density extruder system
- Spheronizer system

General

The base unit and at least one attachment must be chosen. Generally all three attachments are purchased at the same time.

Product contact	316 stainless steel FDA food approved plastics
Batch size	A wet batch of about 50 g is normal
Timer	Automatic timer included
Power requirement	230V, 50Hz, 6.3A or 110V, 50Hz, 10A. 1 ph. Configuration selected at time of order

The base unit

Size	Approximately 480w x 375h x 375d mm
Weight	34.2 kg (220V) or 36.4 kg (110V)
Cabinet	Brushed type 304 Stainless Steel

The granulator attachment

Standard bowl	Inter-meshing counter rotating blades for the highest possible shear
Half bowl	A smaller "half-bowl" is available for use with scarce or expensive product
High viscosity bowl	Non inter-meshing "z" blade option for mixing materials of higher viscosity
Water jacket	Bowls with or without water jacket are available
Blade rotation speed	Blade A: 15 to 235 rpm Blade B: 30 to 470 rpm

Extruder Attachment

Standard die plates	One 1 mm diameter standard density and one 1 mm high density dies are included as standard
Diameter options	From 0.5 to 3.0 mm holes are available
Variable density dies	Additional high density and low density dies are available. Discuss your requirement with us.
Extrusion screws	Two different interchangeable screw designs that offer you the opportunity to work with a wider range of experimental materials.
Screw speed	15 to 235 rpm
Product output	Extrusion pressure can be modified using additional dies

Spheronizer attachment

Processing capacity	10 to 100 g wet weight (formulation dependent)
Speed range	300 to 4,600 rpm
Disc	Different disc patterns are available. Ask for details



Support

✔ Support and advice options.....

"Is Caleva able to offer advice about the products that I should obtain to achieve my established objectives?"

Development and production equipment is normally a significant purchase that should be suitable for what you want to do for several years into the future. It is important that the right decisions are taken before the equipment purchases are decided.

For many purchasers, the technology that they are investing into is relatively new and may not be well known.

In these cases, the time to obtain advice is before the purchase decisions are made.

We at caleva have been making pellets and extrudates for about 50 years. If you will share with us what you are trying to achieve then we would be in a good position to share with you our experience. This should enable you to be confident that the equipment that you buy is appropriate for your project.

This support and advice should be used before purchase decisions are made. We will give this help free of charge.

✔ Reduce your batch size.....

"Can I work with smaller batch sizes with the CML if my product is very expensive or scarce?"

For some applications where an increase in mixing power is needed (for example in the case of very stiff materials) then a smaller bowl might provide a solution. The smaller bowl has a batch size of about 10 to 20 grams (wet weight) and using smaller blades provides more power to be applied to a smaller mixing surface. Mixing bowls can be used with or without inserts as required.

In the case of very scarce or expensive materials then a small bowl will help to run trials with smaller amounts of material.

Using 15 grams of material in the smaller mixing bowl will provide a sample that is still large enough to effectively use in the extruder and spheronizer.

Ask us about the reduced size mixing bowl and blade set.

Granulation

✔ Cool or heat the material in the bowl.....

"My product is sensitive to excessive heat or may not mix properly when cold."

"Can I cool or heat the material in the MTR3 mixing bowl during my trials?"

Some experimental work might benefit from product that is either heated or cooled in the CML granulator mixing bowl during the experimental process.

A water jacketed bowl suitable for heating or cooling can be offered with both the full size and the reduced

size bowls. A separate water bath and circulation pump will be necessary.

Caleva can also provide a heating and cooling water circulatory system if required, but most customers generally source this from their local supplier.

✔ Stiff or viscous material.....

"My material is very viscous. Do you have options for a different blade configuration to work with these materials?"

For working with very "high viscosity" materials an advanced sigma blade has been designed. This allows a more viscous type of material to be

effectively mixed or granulated in the CML system. Contact us for details.





TO HELP YOU ACHIEVE MORE

✓ Validation and training options.....

✓ “Will caleva be able to offer a full validation package for my equipment if this is necessary?”

Caleva can offer a range of training and validation options. These can be customized so that they are appropriate for your specific requirements.

A summary is given below. You should discuss your actual needs with us so that an appropriate package can be offered.

✓ Factory acceptance test (FAT) at the Caleva site

An ISO 9002:2015 compliant and certified quality check is completed before equipment is shipped (a copy is supplied to the customer if requested). A separate FAT is not normally necessary but can be performed if required.

You can attend if you wish to do so. We can provide local assistance, but you will be responsible for your own expenses incurred or your transportation, subsistence, and accommodation.

✓ Customer training at the Caleva site

Training is optional, but recommended if the process of extrusion and spheronization is new to you or your staff would benefit. We offer training at our site before the equipment is shipped or

at your site after the equipment has arrived. If either of these options are not suitable then we can offer training and installation support by Skype (or similar).

✓ Installation, training and validation at your site

A full set of options for training, installation and validation of all Caleva equipment can be offered at your site. The details will depend on your location

and your specific equipment. Contact us to discuss your preferences and we will put together a proposal for you.

✓ Full validation and/or provision of IQ/OQ documentation and/or material certificates

With Caleva assistance at Caleva site:

The IQ/OQ package can be completed (as far as possible) at the Caleva site by us. You may attend if you wish to do so. An additional set of blank documents is provided to allow you to re-do the IQ/OQ in your own facility after installation.

IQ/OQ then a set of blank documents can be purchased from caleva so that you can complete this at your site without a Caleva presence.

With Caleva assistance at customer site:

IQ/OQ and installation completed at the customer site at the same time as installation and training.

Provision of blank IQ/OQ documents only:

If you do not require assistance to complete the

Provision of material certificates only:

Consistent with most companies today Caleva does not automatically offer material certificates for product contact parts. Caleva will provide free of charge a letter confirming that material certificates will be available for purchase by the original purchaser for a period of 12 months from the date of purchase. Material certificates can be purchased if required.



TO HELP YOU ACHIEVE MORE

✔ Formulation development optimization.....

"Can Caleva suggest something to help me develop my formulations?"

The Caleva MTR is well established as a valuable formulation development, formulation research and production quality control tool.

It provides a fast, quantitative and reproducible measurement of the wet mass in terms of the torque produced when shearing the granulation within the pivoted mixing bowl.

This ability allows formulations to be optimised and product and excipient quality issues to be identified. A valuable tool for formulation development.

Please talk to us about the Mixer Torque Rheometer and ask us about available case studies.

Please ask us for more information.



✔ Drying and coating pellets.....

"The batch sizes of my pellets produced are very small. What can I use to apply functional or cosmetic coatings to these small batches?"

If you are producing small quantities of pellets with the Caleva Multi Lab and these require drying or coating then the best drying and spraying equipment that can operate with such small sample sizes is the Caleva Mini Coater Drier.

Small quantities of small particles (**from a few grams**) can be coated and dried in minutes.

Other pellet coaters might require a minimum batch of between 300 g and 500 g to work effectively. This robust, simple-to-operate, bench-top unit provides a cost-effective solution for drying and coating particles fully compliant with principles of GLP.

Please talk to us for more information.



Included in the standard Caleva Multi-Lab package

1. The base unit.

Let us know if you prefer or require a 110 volt or a 220-240 volt machine.

2. The mixer/granulator attachment with a plain bowl and standard blade set.

Talk to us if you think you may need a high viscosity bowl and blade set.

3. The extruder attachment with a 1 mm diameter hole standard die and a 1 mm diameter hole high pressure die.

Ask us about extra dies that offer higher or lower extrusion pressure.

4. Two interchangeable extruder screws

Two different screw designs that offer you the opportunity to work with a wider range of experimental materials

5. The spheronizer attachment.

Comes with a standard cross hatch disc. If your material is sticky consider a non-stick coating on the drum and/or the disc.

We work world-wide with these industry sectors:-
Agriculture, Aquaculture, Biotechnology, Catalyst, Ceramics, Cosmetics, Detergents, Food, Nutraceuticals, Pharmaceuticals

SOME OF THE SUCCESSFUL COMPANIES THAT HAVE SHOWN THEIR TRUST IN CALEVA BY WORKING WITH US



Nothing else offers so many experimental options in a single package, or facilitates trials to be completed so quickly!

Increase your chances of development success

TALK TO US

+44 (0) 1258 471122

info@caleva.com

www.caleva.com



ISO 9001:2015
Cert. No. 1503

Ver 00702